

ROOSEVELT 34 & ROOSEVELT 29

TRADITIONAL LOG | BIRCH LOG
GAS INSERT

Roosevelt 29 Birch Log shown with an Arched Mission screen front in Vintage Bronze, and a Chicago Brick refractory



QUALITY FIREPLACES FOR LIFE.

KOZY  HEAT
FIREPLACES

Roosevelt 29 Traditional Log shown with Rectangle Screen Front in Antique Copper, and Herringbone refractory



ROOSEVELT SERIES

Safety Screen Fronts

Sizes shown below: Roosevelt 34 / Roosevelt 29

34-1/8" / 30-5/8"

24-1/2" / 20-5/16"



Rectangle Screen Front
with Traditional Logs & Black Glass panels
Available in Black

34-1/8" / 30-5/8"

24-1/2" / 20-5/16"



Rectangle Screen Front
with Birch Logs & Black Glass panels
Available in Antique Copper, Brushed Nickel

35" / 30-5/8"

24-5/8" / 20-5/16"



Arched Mission Screen Front
in Vintage Bronze with Traditional Logs & Chicago Brick refractory
Available in Vintage Bronze

Roosevelt 29 Traditional Log shown with a Rectangle screen front, and Black Glass panels



Prairie Screen Front
with Traditional Logs & Herringbone refractory
Available in Black, Rust, Titanium



Arched Prairie Full Door
with Birch Logs & LedgeStone Refractory
Available in Black

Roosevelt 34 Birch Log shown with Rectangle screen front and Black Glass panels



ROOSEVELT SERIES

Media & Refractory Options



Traditional Logs
with Herringbone refractory



Birch Logs
with Black Glass panels

Refractory Options



Black Brick



Chicago Brick



Ledgestone



Herringbone



Black Glass



Roosevelt 34 Traditional Log shown with a Prairie screen front, and a Chicago Brick refractory

Burn Videos



Roosevelt 29
Traditional Logs



Roosevelt 29
Birch Logs



Roosevelt 34
Traditional Logs









Roosevelt 34
Birch Logs



KOMFORT KONTROL™

The Komfort Kontrol remote gives you the ability to bring comfort and green technology all together into your home. With the Komfort Kontrol remote, all you have to do is decide a comfortable set point temperature on your remote and when the room temperature gets closer to the point you desire, the Komfort Kontrol remote will turn the flames down accordingly! And with our zone heating, you can save energy and enjoy time in the room you use the most by just turning down the central heat, setting your Komfort Kontrol remote, and enjoy your time around the fireplace with friends, family, or just a good book! That way you'll get to have heat where and when you need it while saving energy and money with just a click of the Komfort Kontrol remote!

Remote control features:

-  Thermostat function
-  Flame height modulation
-  Fan speed modulation
-  Light kit modulation
-  IPI to continuous pilot
-  Split Flow Option

ROOSEVELT SERIES

Specifications

Venting

A gas insert will help in eliminating the heat loss and cold down drafts that you have likely experienced from your existing fireplace and chimney. As the first company to introduce direct-vent technology to gas inserts, Kozy Heat inserts and fireplaces use 100% outside air for combustion. Our inserts and dual 3" aluminum flex venting structure create a sealed system and eliminates the potential of bringing smoke or fumes into the home. When compared to gas logs or "ventless" inserts, this is the safest and most efficient choice that you can make for your family.

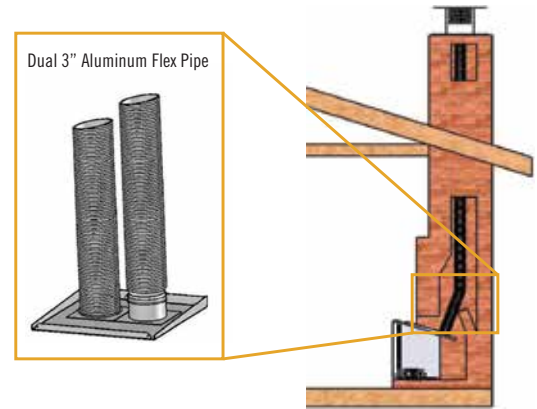

Clearances to Combustibles

For Roosevelt 34 & 29

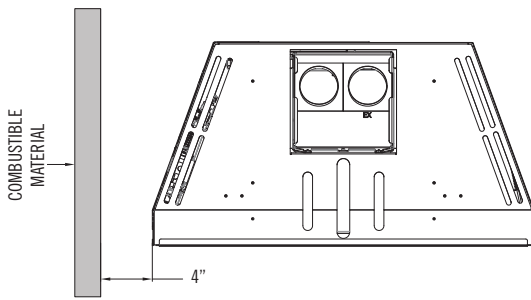

Roosevelt 29

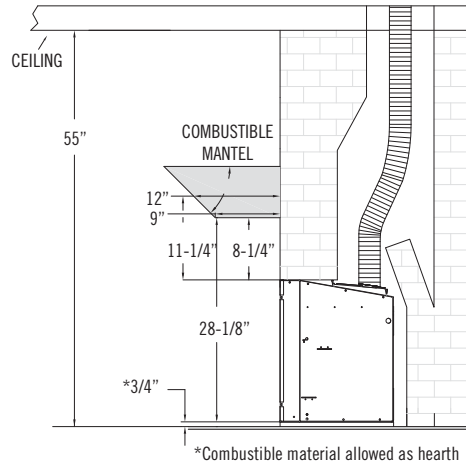

Model	Roosevelt 34	Roosevelt 29
Height	23-3/4"	19-7/8"
Front Width	33-7/8"	29-5/8"
Back Width	24"	20-1/16"
Depth	16-3/8"	16"
Weight	145 lbs	125 lbs
Viewing Area	28-3/8" x 20"	25-1/8" x 15-1/2"
BTU NG High / Low	40,000 / 10,000	30,000 / 10,000
BTU LP High / Low	40,000 / 10,000	30,000 / 10,000
ENERGUIDE P4 NG / LP	70.68% / 70.05%	70.09% / 70.42%
STEADY STATE NG / LP	73.63% / 73.45%	74.96% / 75.85%
AFUE% NG / LP	73.05% / 72.81%	74.35% / 68.56%
Valve System	IPI	IPI
Media Options	Traditional Logs & Birch Logs	Traditional Logs & Birch Logs
Refractory/Panel Options <i>(Required for Installation)</i>	Black Brick, Chicago Brick, Ledgestone, Herringbone, Black Glass Panels	Black Brick, Chicago Brick, Ledgestone, Herringbone, Black Glass Panels
Rear Split Flow Burner	Standard	Standard
Ember Bed Light Kit	Standard	Standard
Fan Kit	Standard	Standard
Screen Front	Required	Required

Roosevelt 34

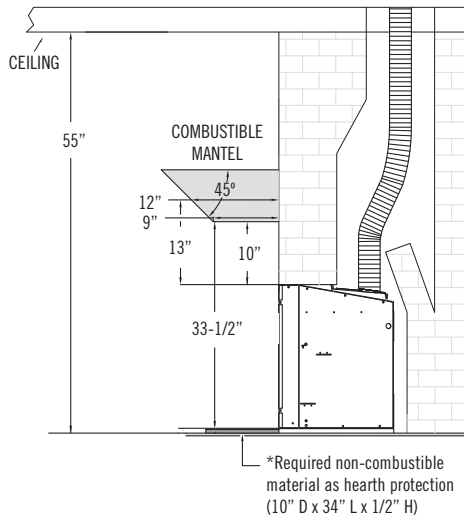

*If removing existing floor, see manual for floor protection requirements.

Each unit factory tested

Certified to ANSI Z21.88 Vented Gas Heaters

Refer to the installation manuals for complete installation & venting requirements. See additional mantel clearance configurations in the installation manual.

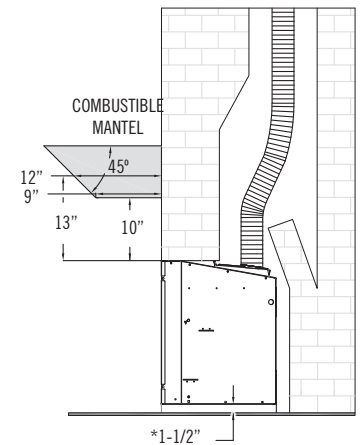

*If combustible flooring is constructed in front of the unit, the appliance must be raised 1-1/2" (38mm) using a non-combustible material

Features, Options & Specifications are subject to change.

Roosevelt 34

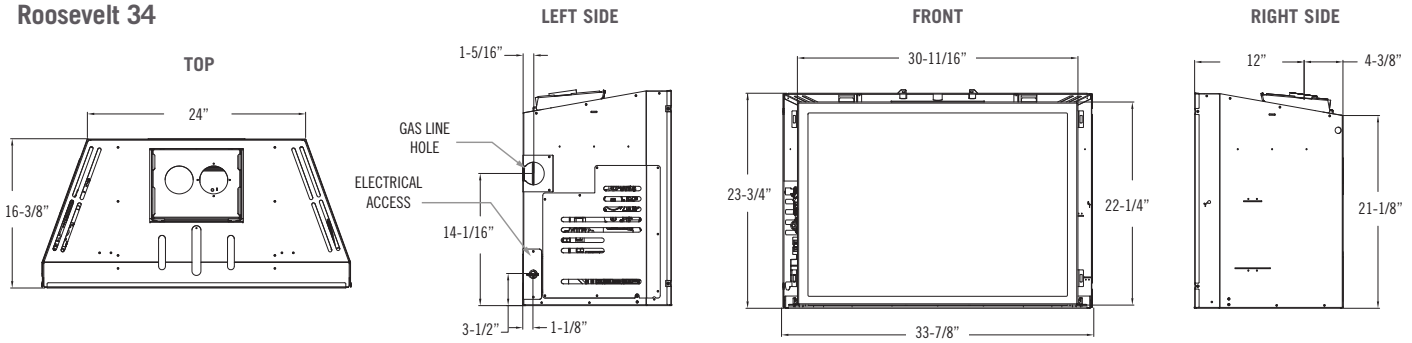

Roosevelt 29

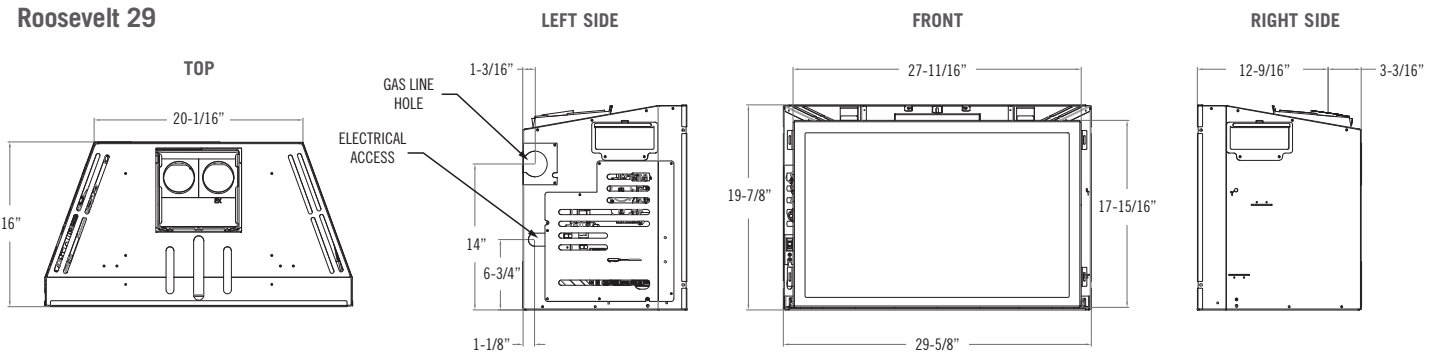

Existing Fireplace Requirements

Roosevelt 34

Existing Fireplace Opening must be at least:

- Height: 23-3/4"
- Front Width: 34-1/8"
- Depth: 16-3/8"
- Back Width: 24-1/8"

Existing Chimney:

Inside Diameter:

- Factory built solid fuel chimney: 7" min
- Masonry Chimney: 6" x 8" min
- Minimum Chimney Height: 10'
- Maximum Chimney Height:
 Natural Gas: 50'
 Liquid Propane: 50'

Roosevelt 29

Existing Fireplace Opening must be at least:

- Height: 20"
- Front Width: 29-3/4"
- Depth: 16"
- Back Width: 20-3/8"

Existing Chimney:

Inside Diameter:

- Factory built solid fuel chimney: 7" min
- Masonry Chimney: 6" x 8" min
- Minimum Chimney Height: 10'
- Maximum Chimney Height:
 Natural Gas: 50'
 Liquid Propane: 40'

Vent System Approval & Requirements

- Kozy Heat #816 & #816- CAP
- BDM™
- American Metal™ Products (Amerivent)
- Metal Fab™
- Olympia™
- Selkirk Metalbestos™
- ICC™
- Simpson Dura-Vent™

Shroud Dimensions

*Shroud is Required for Installation

Roosevelt 29

- 25" x 38"
- 27-1/2" x 42"
- 30" x 44"

Roosevelt 34

- 27" x 40"
- 30" x 44"
- 33" x 46"

*Custom sizes available when applicable

Roosevelt 34 Traditional Log with Black Glass panels and an Arched Mission screen front in Vintage Bronze



Fireplace brochures are for advertising purposes only. Refer to the specific fireplace manual for installation.

ROOSEVELT SERIES

Outdoor Covered Fireplace Install

- Fireplace operation is approved from 40 degrees F to 110 degrees F
- All wiring connections shall be in accordance with outdoor requirements of NECA NFPA 70
- All clearances and requirements in your appliance manual must be adhered to

EXAMPLE: If roofline (B) is 10 ft. above the base of the fireplace, the overhang (A) must be 5 ft. or greater. The width of the overhang to EACH side of the fireplace (C) must be 5 ft. or greater.

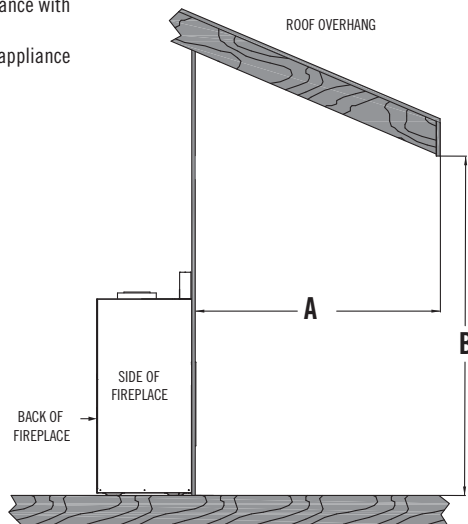

The overhang (A) must be a minimum of 1/2 or greater of the roofline elevation (B) above the base of the fireplace.

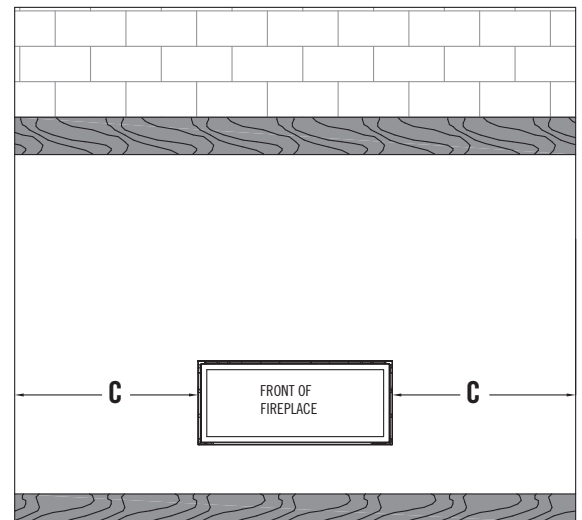

The width of the overhang to each side of the appliance (C) must be a minimum of 1/2 or greater of the roofline elevation (B) above the base of the fireplace.

In order to continually provide the highest quality product available, features/options, specifications, & dimensions are subject to change. Flame appearance and characteristics may be affected by altitude, fuel type, venting configuration, and other factors. Refer to the unit installation manual for complete installation instructions. Installation must conform with local building codes. **In some regions it may be possible that this appliance qualifies for an energy rebate. See your local dealer for details regarding promotions and qualifications.**

Manufactured by Hussong Mfg. Co., Inc.
204 Industrial Park Road, Lakefield, MN 56150
Phone 1-800-253-4904 www.kozyheat.com

10-22



Product Line:



For complete information on the Kozy Heat product line, please contact us at:

FOR CALIFORNIA RESIDENTS ONLY
⚠ California Proposition 65 Warning

WARNING: This product can expose you to chemicals including Carbon Monoxide, that is an externally vented by-product of fuel combustion, which is [are] known to the State of California to cause birth defects or other reproductive harm. For more information, visit www.P65Warnings.ca.gov.